



**INSTRUCTIONS D'ASSEMBLAGE**  
**ASSEMBLY INSTRUCTIONS**

---

**M**ONARCH  
SPECIALTIES INC.

# I 3735

---

**TABLE D'APPOINT -**  
**42"L / RANGEMENT / MIROIR / ARGENT**

**ACCENT TABLE -**  
**42"L / MIRROR / SILVER WITH STORAGE**





**POUR DE L'ASSISTANCE OU POUR COMMANDER  
DES PIÈCES CONTACTEZ NOTRE DÉPARTEMENT  
DE SERVICE À LA CLIENTÈLE.**

**FOR ASSISTANCE OR TO ORDER PARTS  
CONTACT OUR CUSTOMER SERVICE DEPARTMENT**

**[WWW.MONARCHSERVICE.COM](http://WWW.MONARCHSERVICE.COM)**

---

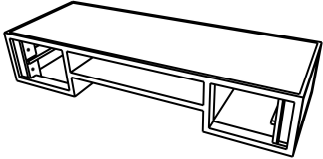
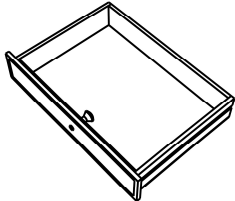
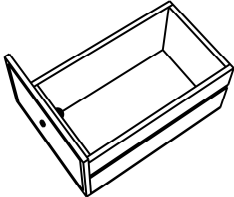
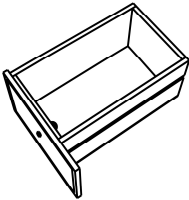
**LISTE DES PIÈCES**  
**PARTS LIST**

PIÈCE / PART #	IMAGE	DESCRIPTION	QTY / QTÉ
1		<p>CABINET TOP SURFACE DE L'ARMOIRE</p>	1
2		<p>DRAWER TIROIR</p>	1
3		<p>DRAWER TIROIR</p>	1
4		<p>DRAWER TIROIR</p>	1
5		<p>LEG PATTE</p>	4

**LISTE DES PIÈCES DE MONTAGE**  
**HARDWARE LIST**

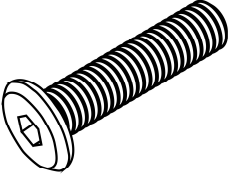
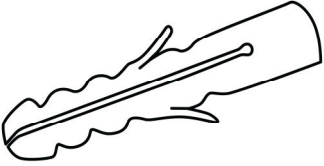
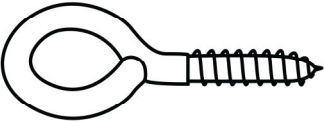
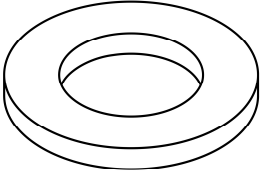
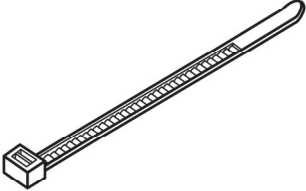
PIÈCE / PART #	IMAGE	DESCRIPTION	QTY / QTÉ
A		ASSEMBLING BOLT - 3/8" X 1 3/8" BOULON D'ASSEMBLAGE - 3/8" X 1 3/8"	8
B		ANCHOR ANCRE	1
C		EYELET SCREW VIS A OEILLET	1
D		METAL WASHER RONDELLE DE MÉTAL	8
E		ZIP TIE ATTACHE AUTOBLOQUANTE	1

**LISTE DES PIÈCES DE MONTAGE**  
**HARDWARE LIST**

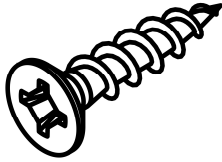
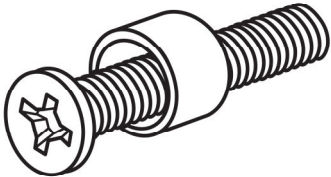
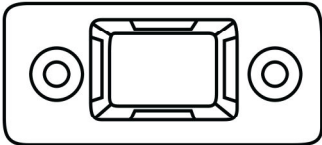
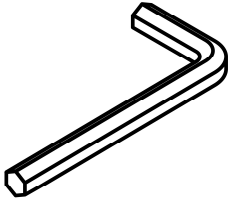
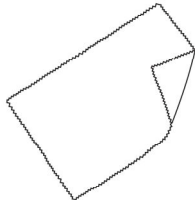
PIÈCE / PART #	IMAGE	DESCRIPTION	QTY / QTÉ
F		ASSEMBLING SCREW VIS D'ASSEMBLAGE	2
G		BOLT SET - 1/8" X 1/2" ENSEMBLE DE BOULON - 1/8" X 1/2"	3
H		PLASTIC BRACKET SUPPORT EN PLASTIQUE	1
I		HEX KEY CLÉ HEXAGONALE	1
J		POLISHING CLOTH TISSU DE POLISSAGE	1



OUTIL DE VÉRIFICATION DE DIMENSIONS DES PIÈCES  
HARDWARE DIMENSIONS VERIFICATION TOOL



ÉTAPE / STEP 1

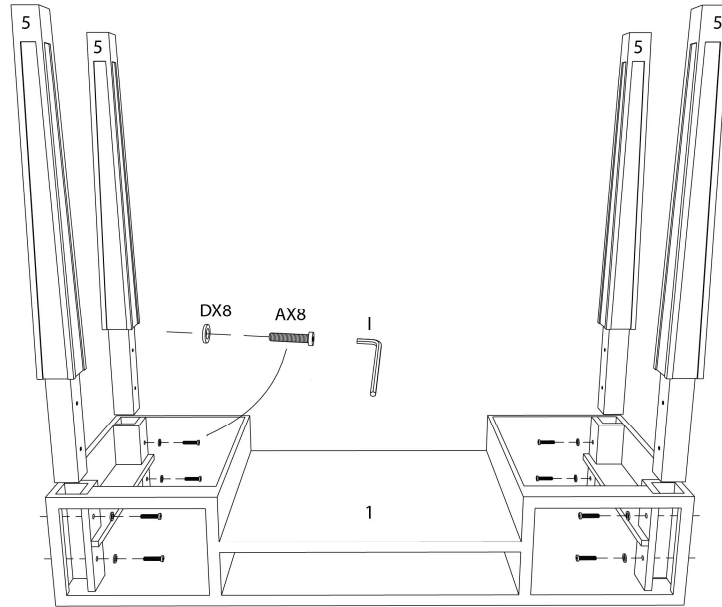

ÉTAPE / STEP 2

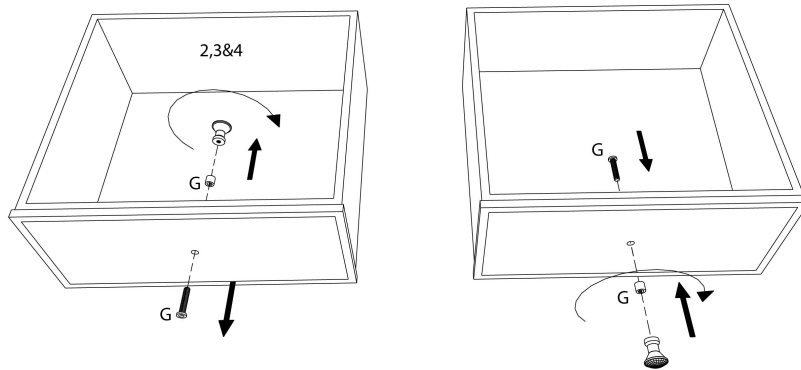

ÉTAPE / STEP 3

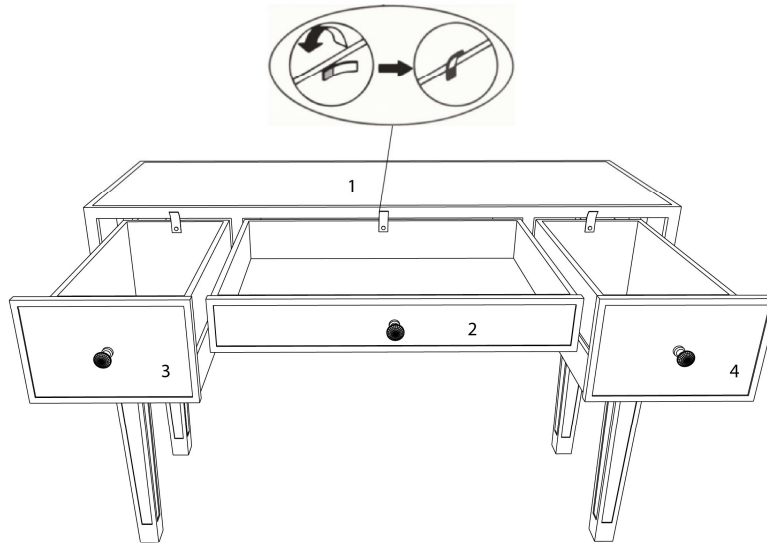

ÉTAPE / STEP 4

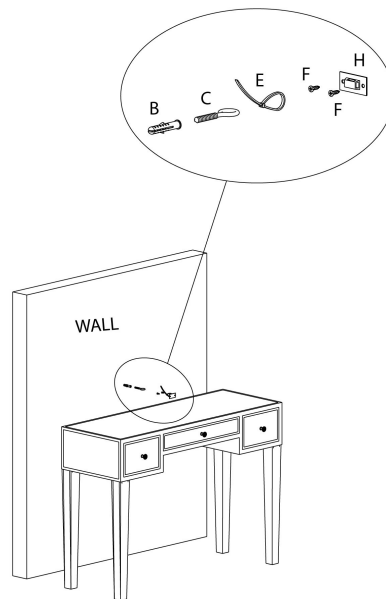

ÉTAPE / STEP 5

