



**INSTRUCTIONS D'ASSEMBLAGE**  
**ASSEMBLY INSTRUCTIONS**

---

**M**ONARCH  
SPECIALTIES INC.

**I 7267**

---

**CHAISE DE BUREAU -**  
**NOIR / MECHE NOIR / MULTIPLE POSITION**

**OFFICE CHAIR -**  
**BLACK / BLACK MESH / MULTI POSITION**





**POUR DE L'ASSISTANCE OU POUR COMMANDER**  
**DES PIÈCES CONTACTEZ NOTRE DÉPARTEMENT**  
**DE SERVICE À LA CLIENTÈLE.**

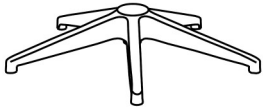

**FOR ASSISTANCE OR TO ORDER PARTS**  
**CONTACT OUR CUSTOMER SERVICE DEPARTMENT**

**WWW.MONARCHSERVICE.COM**

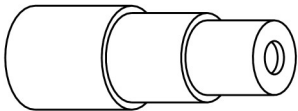
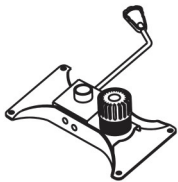
**LISTE DES PIÈCES**  
**PARTS LIST**

PIÈCE / PART #	IMAGE	DESCRIPTION	QTY / QTÉ
1		<p><b>CASTOR</b>  <b>ROULLETTE</b></p>	5
2		<p><b>BASE</b>  <b>BASE</b></p>	1
3		<p><b>GASLIFT</b>  <b>ASCENSEUR À ESSENCE</b></p>	1
4		<p><b>TELESCOPIC COLUMN COVER</b>  <b>COUVERTURE DE COLONNE</b>  <b>TÉLÉSCOPIQUE</b></p>	1
5		<p><b>CHAIR MECHANISM SEAT PLATE</b>  <b>MÉCANISME DE SIÈGE</b></p>	1

**LISTE DES PIÈCES**  
**PARTS LIST**

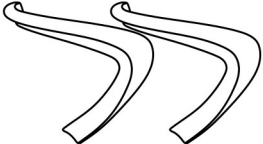
PIÈCE / PART #	IMAGE	DESCRIPTION	QTY / QTÉ
6		<p align="center"><b>BACK REST</b> <b>DOSSIER</b></p>	1
7		<p align="center"><b>SEAT CUSHION</b> <b>COUSSIN DU SIÈGE</b></p>	1
8		<p align="center"><b>ARM REST</b> <b>ACCOUDOIR</b></p>	2

**LISTE DES PIÈCES DE MONTAGE**  
**HARDWARE LIST**

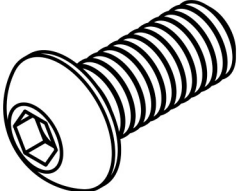
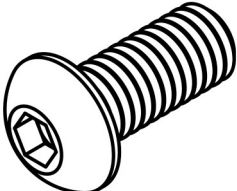
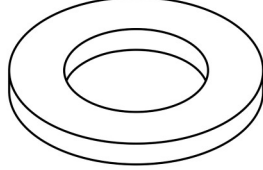
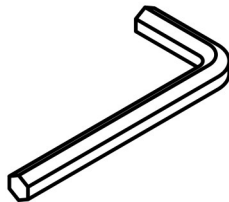
PIÈCE / PART #	IMAGE	DESCRIPTION	QTY / QTÉ
A		<p align="center">ASSEMBLING BOLT - Ø 1/4" X 3/4" BOULON D'ASSEMBLAGE - Ø 1/4" X 3/4"</p>	6
B		<p align="center">ASSEMBLING BOLT - Ø 1/4" X 1 1/4" BOULON D'ASSEMBLAGE - Ø 1/4" X 1 1/4"</p>	10
C		<p align="center">METAL WASHER RONDELLE DE MÉTAL</p>	10
D		<p align="center">HEX KEY CLÉ HEXAGONALE</p>	1



OUTIL DE VÉRIFICATION DE DIMENSIONS DES PIÈCES  
HARDWARE DIMENSIONS VERIFICATION TOOL



ÉTAPE / STEP 1

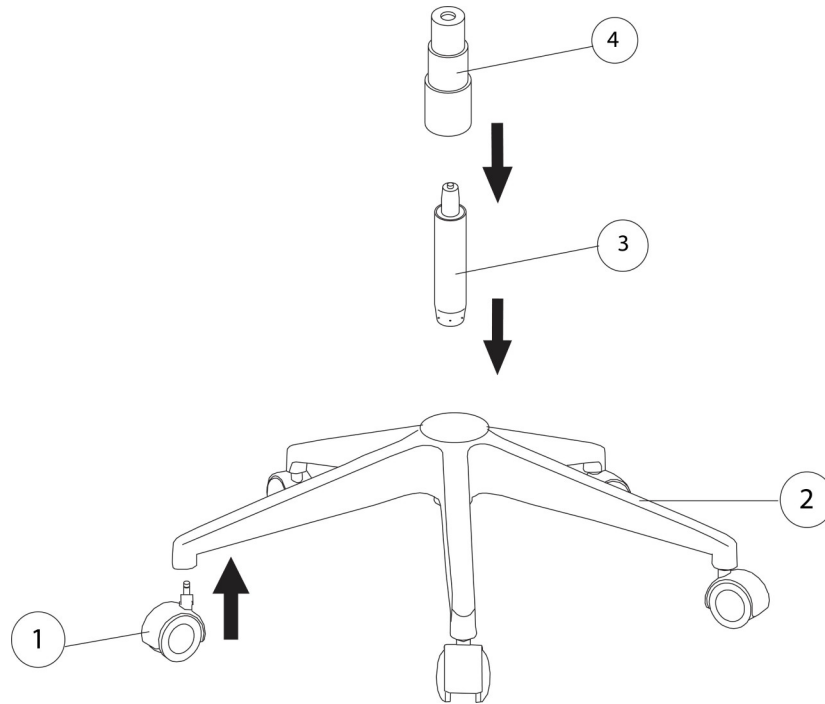

ÉTAPE / STEP 2

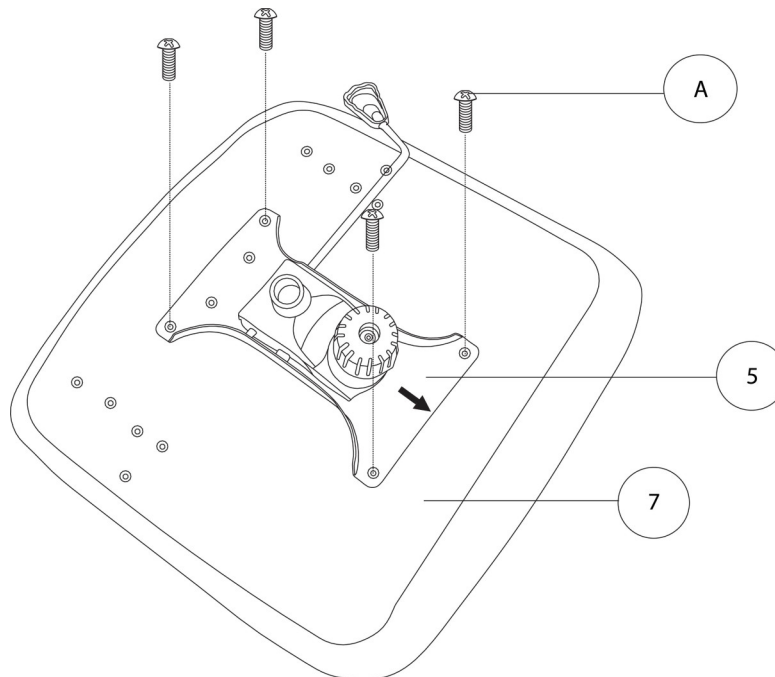

ÉTAPE / STEP 3

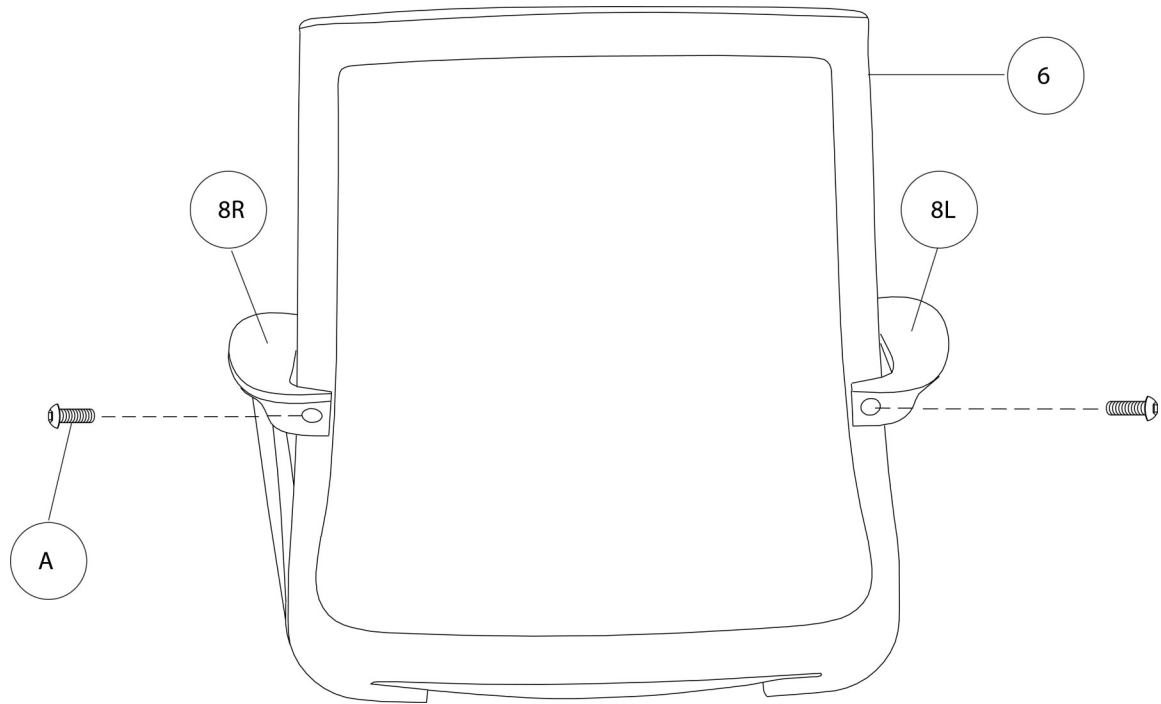

ÉTAPE / STEP 4

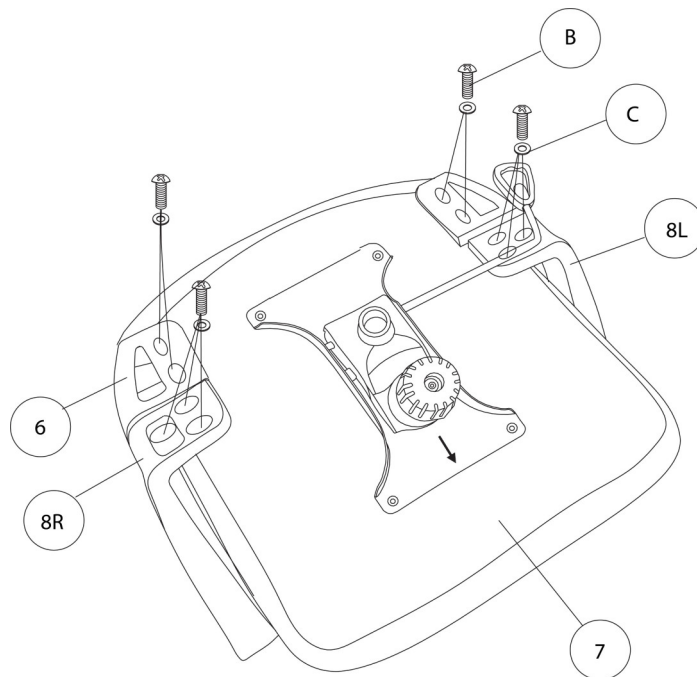

**ÉTAPE / STEP 5**

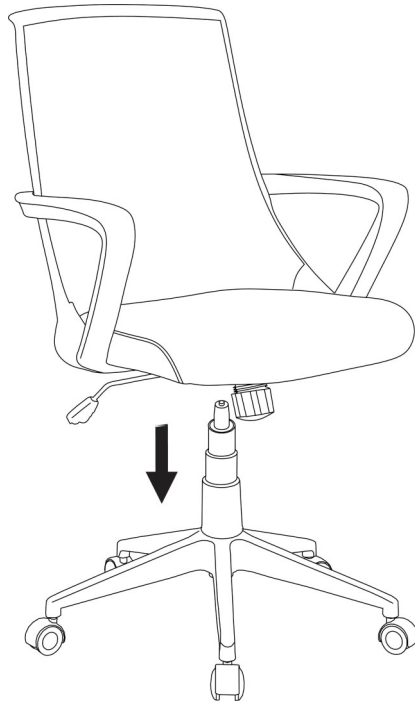



ÉTAPE / STEP 6

